

20 Ottobre 2020

WEBINAR



#LAUMASKNOWHOW

LAUMAS[®]
Innovation in Weighing

LAUMAS: CHI SIAMO?



STORIA – DATE IMPORTANTI

1984

Anno di fondazione. Luciano Consonni avvia l'attività in un piccolo laboratorio a Parma e fonda LAUMAS, accostando le iniziali dei figli, Laura e Massimo, attuali titolari insieme al padre nella guida dell'azienda.

2002

Dopo diversi cambi di sede, LAUMAS si trasferisce nella sede attuale di Montechiarugolo (PR), che ricopre un'area di circa 2000 m² e dispone di un ulteriore magazzino esterno di 1000 m².

2007

LAUMAS avvia gli investimenti che porteranno alla realizzazione del nuovo reparto di Ricerca e Sviluppo, dotato di laboratorio con attrezzature all'avanguardia.

2012

LAUMAS rinnova completamente la gamma dei propri prodotti, presentando sul mercato delle nuove linee di Indicatori e Trasmittitori di peso decisamente innovativi e completamente "MADE IN ITALY".

2018

LAUMAS amplia la propria sede e inaugura nuovi uffici, sale conferenze, una sala dedicata ai Webinar, un Laboratorio Metrologico e un nuovo Magazzino di 1000 m².

NUOVA SEDE



Nuovo edificio
2000 m²

Edificio esistente
2000 m²

Sale riunioni
Aree Relax

Nuovo magazzino
Nuovi uffici

**OTTOBRE
2018**

Impianto
fotovoltaico
145 kW

Laboratorio
metrologico

Superficie totale
4000 m²

Tipologie
di articoli
>2000

LABORATORIO METROLOGICO

- **Calibrazione** celle di carico e linearizzazione
- **Certificati** riferibili **UNI EN 17025**:
ISO 376 e ASTM E 74 o calibrazione (ISO 9001)
- **Accreditamento** ad **Accredia**



MAGAZZINO

- Valore €4 200 000,00
- 600 000 articoli (finiti e semilavorati)
- Superficie **2000 m²**



VENDITE

2019

Fatturato: €12 650 000,00

Celle di carico:
44 816 pz

Elettroniche:
33 371 pz



Load Cells sold in 2013 - 2019

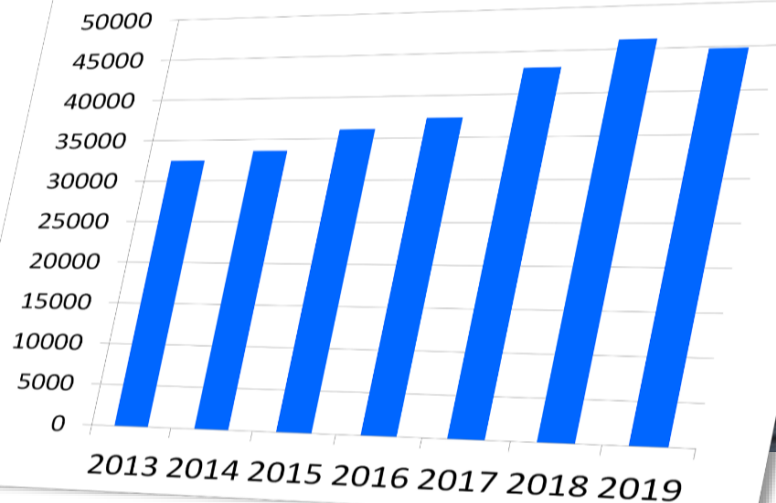

Weight Indicators and Transmitters sold in 2013 - 2019

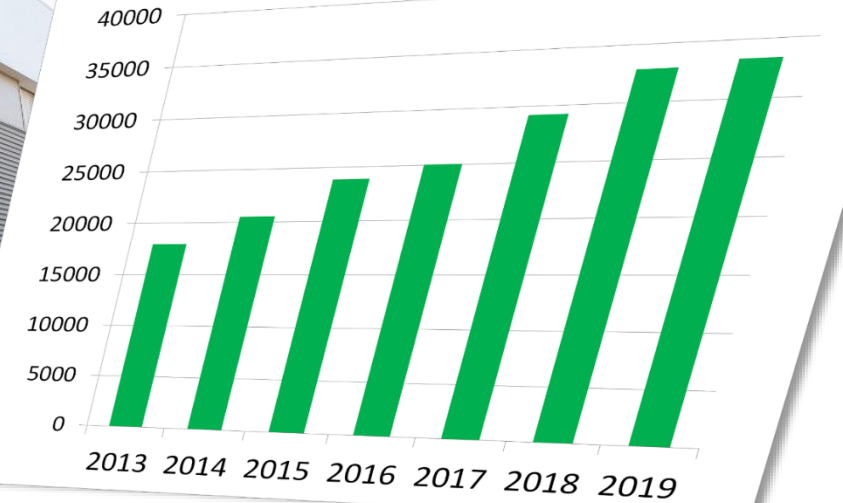

AZIENDA INTERNAZIONALE

Processo di internazionalizzazione in costante espansione, che ha portato ad incrementare la quota di EXPORT dal 18% del 2011 al 36% del 2019.

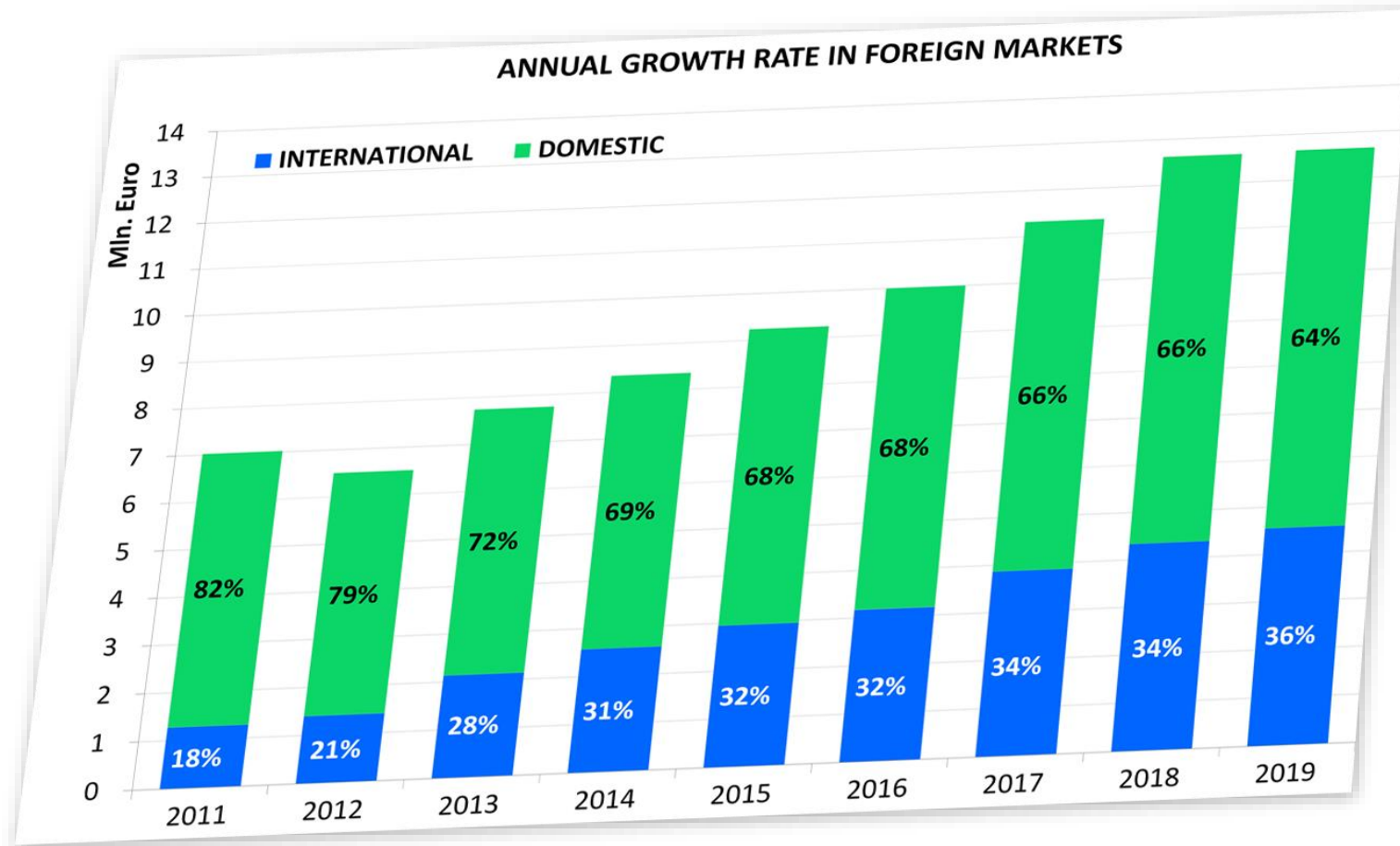

PUNTI DI FORZA

- Costante attività di ricerca e sviluppo per la continua innovazione dei prodotti
- Prodotti affidabili con ottimo rapporto qualità/prezzo:
 - 100% dei prodotti testati prima della spedizione
- Consulenza e Assistenza pre-vendita
- Merce in pronta consegna: spedizione di prodotti standard in massimo 5 giorni
- Assistenza tecnica post-vendita rapida ed efficace



LAUMAS “INNOVATION IN WEIGHING”



RICERCA E SVILUPPO: LABORATORIO ELETTRONICO

**Compatibilità
elettromagnetica**

**Sicurezza
elettrica**

**Prove
d'immunità**

**Prove
emissioni**



RICERCA E SVILUPPO: LABORATORIO METROLOGICO

**Macchine prova fino a 10ton
(con camera climatica)**

Macchine prova fino a 50ton



PRODOTTI - CATEGORIE



INDICATORI DI PESO: SERIE W



SOFTWARE MULTIPROGRAMMA

- Pesata semplice
- Contapezzi
- Controllo statistico preconfezionati
- Carico
- Scarico
- Multiprodotto
- Pesa a ponte

POSSIBILI INSTALLAZIONI

- Fronte quadro
- A parete
- Da tavolo
- Su colonna
- Ambienti ATEX/IECEX

VELOCITA' DI TRASMISSIONE

- Fino a 300 Hz

CONNETTIVITA'

- USB
- Ethernet
- Trasmissione Wi-Fi
- BUS di campo per PC/PLC



INDICATORI DI PESO: WLIGHT - W100



WLIGHT

- Pesata semplice
- Installazione a fronte quadro (W100), a tavolo, a parete e su colonna (WLIGHT)
- Porte seriali (RS485 e/o RS232), uscite a relè (W100), uscita analogica (W100)



W100



solo W100



INDICATORI DI PESO: PROGRAMMI DI DOSAGGIO E PER PESA A PONTE



W200



WDOS

- **Programmi disponibili:** dosaggio (pesata semplice, carico, scarico, multi-prodotto) e pesa a ponte.

- Diverse possibilità d'installazione e di display

- Porte seriali (RS485, RS232), uscite a relè, uscita analogica

- Vasta gamma di BUS di campo



WINOX-L



WDESK-BL



WTAB-G



WINOX-BGE



TRASMETTITORI DI PESO



- Ritrasmissione del valore di peso ad indicatori, PC e PLC
- Display e tastiera per la calibrazione
- BUS di campo per la comunicazione con PC/PLC
- Uscita Analogica, uscite relè, RS485, RS232
- **Monocanale:** TLB, TLS, TLE, TLU
- **Multicanale:** TLB4, TLM8, CLM8
- **LCB:** digitalizzatore, IoT, collegato o solidale alla cella di carico

TRASMETTITORI DI PESO MONOCANALE: TLB

- Display e pulsanti per la calibrazione
- Porta RS485, uscite a relè, uscita analogica o BUS di campo
- Omega/DIN rail mounting

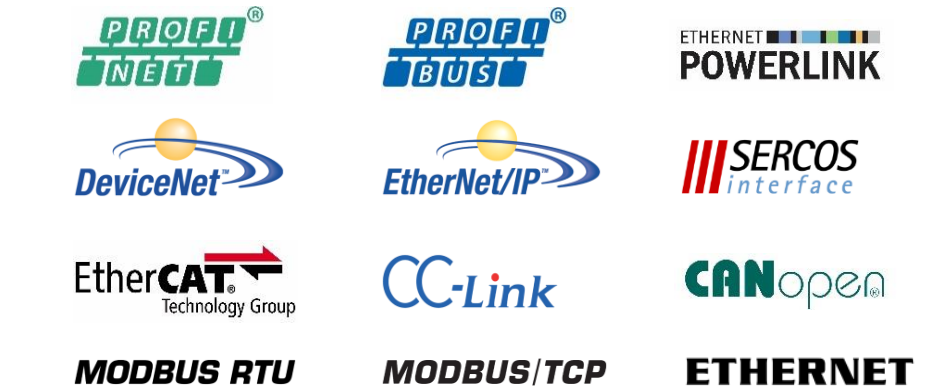

TRASMETTITORI DI PESO MONOCANALE: FAMIGLIA - TL

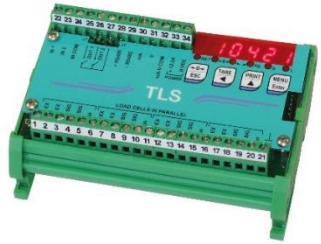

TLS

- Il più diffuso

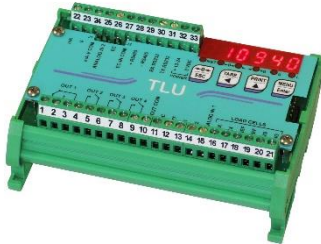

TLU

- Limitatore di carico



TLE

- Economico



- **Scatola in policarbonato** (IP67) per l'installazione in campo
- Installazione su barra Omega/DIN
- Display e calibrazione tramite tastiera o encoder



TRASMETTITORI DI PESO MONOCANALE: LCB



IoT
System

- **Digitalizzatore** per celle di carico
- Collegabile a qualsiasi PLC (**14** BUS di campo disponibili)
- Ideale per qualsiasi sistema **IoT** o **Industry 4.0**
- Integrabile alla cella di carico
- **Acciaio inox AISI316 IP67**
- **Configurabile tramite porta micro USB e software LCB Manager**
- **Programma Base / Carico**

TRASMETTITORI DI PESO MULTICANALE: TLB4 - TLM8

- **Ingressi cella di carico indipendenti**
- Distribuzione in percentuale del peso su ogni cella di carico e memorizzazione
- Equalizzazione digitale
- Diagnostica celle di carico
- Porta seriale RS485, Uscita Analogica o BUS di campo



TRASMETTITORI DI PESO MULTICANALE: TLB4 - TLM8

TLB4

- 4 canali
- Installazione a fronte quadro o su barra Omega/DIN
- Certificazione **NMI per il mercato Australiano e Neo Zelandese**

TLM8

- 8 canali
- Installazione su barra Omega/DIN o in cassetta in policarbonato IP67



TRASMETTITORI DI PESO MULTICANALE: CLM8

CASSETTA DI GIUNZIONE INTELLIGENTE

- Collegamento a qualsiasi indicatore della serie W tramite porta seriale RS485
- **8 canali**
- Uscita Analogica, porte seriali RS232 e RS485, **Ethernet TCP/IP**
- Installazione su barra Omega/DIN, cassetta in policarbonato oppure in acciaio inox.
- Ideale per l'utilizzo come cassetta di giunzione per Pese a Ponte.
- Grazie ad uno special firmware di gestione **INCLINOMETRO**, può compensare i valori di peso con inclinazioni fino a $\pm 10^\circ$, rendendolo quindi ideale per la Pesatura a bordo mezzi.
- La correzione del peso è valida anche per Sistemi omologati per uso legale in rapporto con terzi.

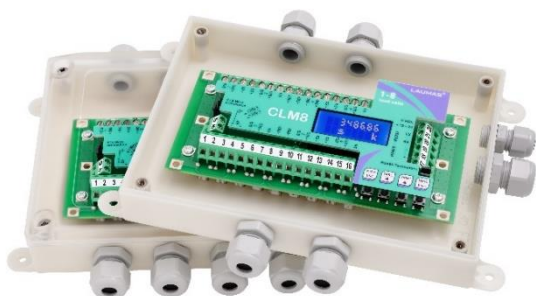
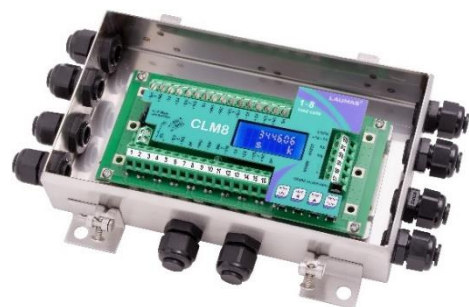

ETHERNET
TCP/IP

CELLE DI CARICO ED ACCESSORI DI MONTAGGIO



- Ampia gamma di celle di carico standard adatte per qualsiasi tipo di Sistemi di Pesatura e misurazioni di forza.
- Portate: da 0.25 kg a 1 000 000 kg

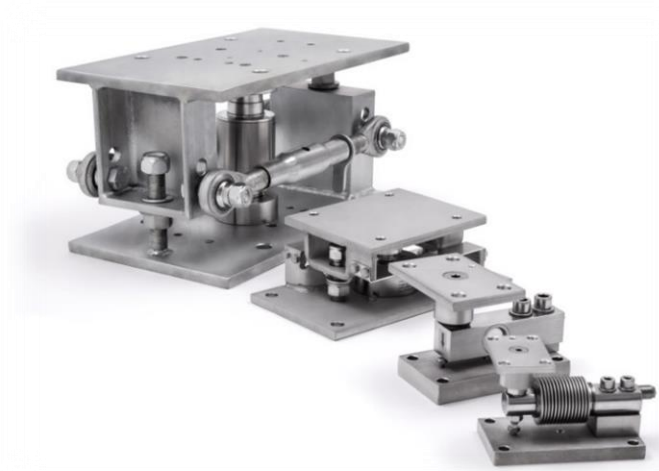

- Per tutte le celle di carico, LAUMAS può fornire **accessori di montaggio** adatti a raggiungere la miglior pesatura possibile.



CELLE DI CARICO OFF-CENTER

Gamma:

- Portate: da 0.25 kg a 2000 kg
- Dimensioni area di pesatura: da 150x150mm a 1200x1200mm
- Grado di protezione IP: da IP65 a IP68 e IP69K

Utilizzo:

- Piattaforme
- Rulliere
- Piccole cisterne / tramogge
- Riempitrici / Confezionatrici
- Pesatura dinamica



CELLE DI CARICO A FLESSIONE / TAGLIO

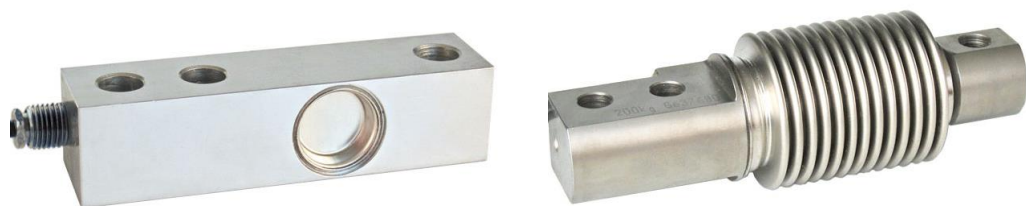

Gamma:

- Portate: da 5 kg a 10 000 kg
- Grado di protezione IP: da IP67 a IP68 e IP69K

Utilizzo:

- Silo
- Tramogge
- Miscelatori
- Rulliere
- Riempi/svuota sacconi

ACCESSORI DI MONTAGGIO

TF Articolazione a compressione per compensare le non planarità

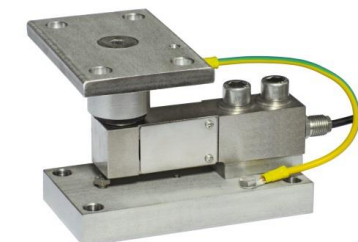

PV

- Piedino snodato per compensare le non planarità
- Sistema anti-ribaltamento
- Altezza regolabile
- Può essere installato sottosopra

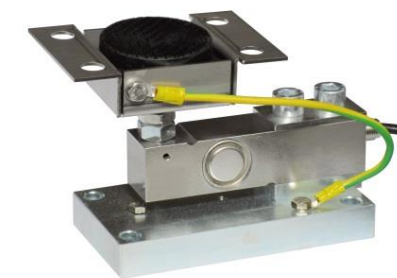

PS

- Snodo sferico per compensare le non planarità
- Sistema anti-ribaltamento
- Resistente agli urti



CELLE DI CARICO A COMPRESSIONE



Gamma:

- Portate: da 200 kg a 1 000 000 kg
- Grado di protezione IP: da IP67 a IP68 e IP69K

Utilizzo:

- Silo
- Tramogge
- Miscelatori
- Rulliere
- Riempi/svuota sacconi

Sono disponibili diverse basi per realizzare accessori di montaggio in autonomia.

ACCESSORI DI MONTAGGIO

- V**
- Sistemi anti-ribaltamento e spinte laterali
 - Installazione Meccaniche senza cella di carico
 - Sostituzione cella senza bisogno di mezzi di sollevamento



- PV**
- Piedino snodato per compensare le non planarità
 - Sistema anti-ribaltamento
 - Altezza regolabile
 - Può essere installato sottosopra



- PS**
- Snodo sferico per compensare le non planarità
 - Sistema anti-ribaltamento
 - Resistente agli urti

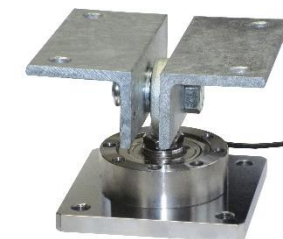

CELLE DI CARICO A TRAZIONE / COMPRESSIONE

TRAZIONE/COMPRESSIONE

Gamma:

- Portate: da 50 kg a 200 000 kg
- Grado di protezione IP:
da IP65 a IP68

Utilizzo:

- Macchine prova
- Presse
- Misurazioni di forza



TRAZIONE

Gamma:

- Portate: da 15 kg a 250 000 kg
- Grado di protezione IP:
da IP65 a IP68 e IP69K

Utilizzo:

- Limitatori di carico
- Gru
- Nastri trasportatori
- Tramogge
- Miscelatori
- Riempi/svuota sacconi
- Macchine prova



ALTRE CELLE DI CARICO ED ACCESSORI DI MONTAGGIO

COMPRESSIONE A COLONNA

Gamma:

- Portate: da 15 000 kg a 60 000 kg
- Grado di protezione IP: IP68

Utilizzo: Pese a Ponte / silo



PERNO

Gamma:

- Portate: da 5000 kg a 20 000 kg
- Grado di protezione IP: IP67

Utilizzo: limitatori di carico / gru



DOUBLE SHEAR BEAM

Gamma:

- Portate: da 13 000 kg a 34 000 kg
- Grado di protezione IP: IP68

Utilizzo: Pesatura a bordo mezzi / pese a ponte / silo

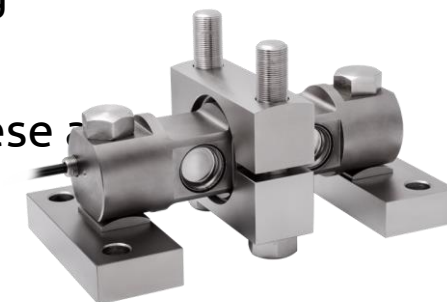

CELLE DI CARICO PER RILEVAZIONE TIRO FUNE

Gamma:

- Portate: fino a 40 000 kg
- Grado di protezione IP: IP67

Utilizzo: limitatore di carico

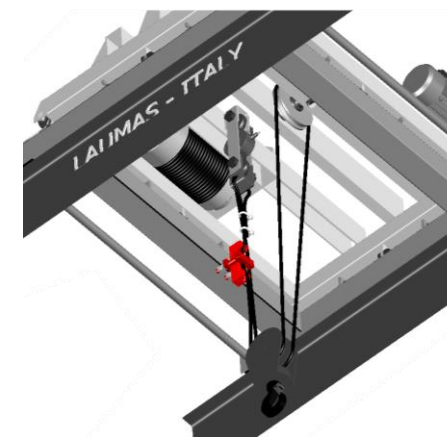

CELLE DI CARICO PERSONALIZZATE



- **Portate:** da 0.1 kg a 1 000 000 kg
- **Grado di protezione IP:** fino a IP68 e IP69K
- Compensazione per Alta/Bassa temperatura
- Con uscita analogica 0-10V / 4-20mA integrata
- Doppio ponte per Sistemi a sicurezza ridondante
- **Bi/tri-assiali**
- Di qualsiasi dimensione o forma in base alle esigenze del cliente
- **Disponibili certificate ATEX e IECEx**

BILANCE – PIATTAFORME - MODULI DI PESATURA

LAUMAS propone anche:

- Piattaforme ad una o quattro celle omologate, adatte ad tipo d'installazione, ambiente e settore industriale
- **Pesa pallet**
- **Barre pesatrici**
- **Bilance contapezzi**
- **Bilance peso-prezzo**
- **Bilance tascabili**
- **Dinamometri**
- **Transpallet pesatori**



Disponibile ultima versione del catalogo

IDEA SCALES



CERTIFICAZIONI DI SISTEMA E PRODOTTO



UNI EN ISO 9001 - UNI EN ISO 14001



NTEP Certifications for commercial weighing and measuring equipment in the U.S. for legal for trade use



ATEX - EC-Type examination
Directive 2014/34/EU – ATEX; zone 0-1-2 gas ; zone 20-21-22 dust



IECEX CoC Certificate
Standards: IEC 60079-0, 60079-11, 60079-31, 60079-15; zone 0-1-2 gas ; zone 20-21-22 dust.



Eurasian Customs Union standard
The EAC mark replaces the GOST



EC-TYPE APPROVAL
(NAWI R76 - MID/AWI R51-R61)



OIML R60 - R61 - R51 - R76



“UL RECOGNIZED COMPONENT”
CERTIFICATION. The U.S. and Canadian standards



EAC Ex for use in potentially explosive atmosphere. TR CU 012 Standards; zone 0-1-2 gas ; zone 20-21-22 dust.



PAC - Pattern Approval Certificate
Russian Federation for weighing instruments for legal for trade use.



NMI Certifications for Australia



NMI Certifications for New Zealand

CONSORZI ED ASSOCIAZIONI



PI
PROFIBUS & PROFINET
International



COMELAB
"Builders - Metrology -
Laboratories« Committee



EPSCG
Ethernet POWERLINK
Standardization Group



ETG
EtherCAT Technology
Group



SERCOS International



CLPA
CC-Link Partner
Association



NCWM
National Conference on
Weights and Measures



GIA
Artisan Companies Group
- Industrial & Tertiary



CANopen
CAN in Automation (CiA)

SETTORI D'IMPIEGO

SOLUZIONI PER APPLICAZIONI INDUSTRIALI



Automazione Industriale



Chimico
Farmaceutico



Alimentare



Trasporto e
Movimentazione

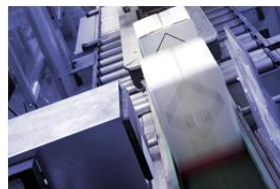

Confezionamento



Sollevamento



Atex



Automotive



Zootecnico



Edile



Tessile e Cartario



Ambiente

SITO E VIDEO

SERVIZI INTERNET GRATUITI

- 500 video prodotti
- Video Tutorial
- Archivio Webinar
- Calendario Webinar
- Video giornate di formazione



AREA CLIENTI

- Download
- Supporto tecnico via Ticket
- Newsletter

SOCIAL MEDIA

SOCIAL NETWORK aggiornati periodicamente



**“Weighing Systems 4.0 > Load cells - Weight Indicators –
Weight Transmitters - Industrial Scales ”**

Il più grande gruppo LinkedIn al mondo sulla Pesatura industriale



REFERENZE INTERNAZIONALI

LORO SI FIDANO DI NOI



All the trademarks are the property of their respective owners:

The Coca-Cola Company, Mapei Spa, Robert Bosch GmbH, Henkel AG & Co., Royal Canin SaS, Basf SE, Procter & Gamble, Ferrero SpA, Danone SA, Unilever Group, Eni SpA, Pirelli & C. SpA, Mondo SpA, AgustaWestland NV, Air Liquide SA, Technogym SpA, Ducati Motor Holding SpA, Davide-Campari Milano SpA, PPG Industries, Lafarge SA, Barilla G. e R. Fratelli S.p.A., Magneti Marelli S.p.A., Enel S.p.A, Piaggio SpA.

RETE VENDITA

RIVENDITORI E CENTRI ASSISTENZA

IN PIU'
DI 100
NAZIONI

Africa	America	Asia	Europa	Russia	Oceania		
Algeria Camerun Costa d'Avorio Egitto Libia Marocco Nigeria Senegal Sudafrica Tunisia Zambia	Argentina Bolivia Brasile Canada Cile Colombia Ecuador Messico Nicaragua Perù Stati Uniti Uruguay Venezuela	Cina Corea del Sud Hong Kong India Indonesia Pakistan Sri Lanka Taiwan Tailandia Vietnam Arabia Saudita Bahrain Emirati Arabi Uniti	Giordania Iran Iraq Israele Giappone Libano Palestina Qatar Turchia Singapore	Albania Belgio Bulgaria Cipro Croazia Danimarca Estonia Finlandia Francia Germania Grecia Lituania Lussemburgo	Macedonia Polonia Portogallo Regno Unito Romania Serbia Slovenia Spagna Svezia Ungheria Lettonia Norvegia Ucraina	Russia	Australia Nuova Zelanda

LAUMAS USA



The graphic features the LAUMAS logo in green and blue, with the website address laumas-us.com below it. To the left, there are icons for a warehouse with a checkmark, a person with a headset and a wrench, and a globe with location pins for Canada and the USA. The text 'READY IN-WAREHOUSE' and 'TECHNICAL SUPPORT' is positioned at the bottom of the graphic.

LAUMAS
laumas-us.com

READY IN-WAREHOUSE TECHNICAL SUPPORT

Stati Uniti d'America e Canada

Magazzino rifornito settimanalmente

Servizio tecnico pre e post vendita in loco

LAUMAS SPORT

BASKET IN CARROZZINA squadra *Polisportiva Gioco Parma*



ZEBRE RUGBY Club nel campionato Guinness Pro14 Championship



LAUMAS SOLIDALE



“God Our Father Centre For Needy Children”
orfanotrofio a Timboni, Malindi, Kenya

www.laumas.com



sales@laumas.it

Scrivici per richiedere
**l'attestato di partecipazione o
ulteriori informazioni**



[Webinar & Tutorials](#)

L'archivio dei **Webinar** e
dei video **Tutorial** per una
formazione completa

#LAUMASKnowHow



[Calendario Webinar](#)

Consulta il programma
dei prossimi corsi online e
scegli quello che fa per te

Grazie per l'attenzione!